

접지자재

침상 접지봉

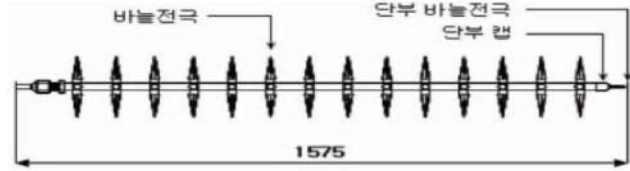
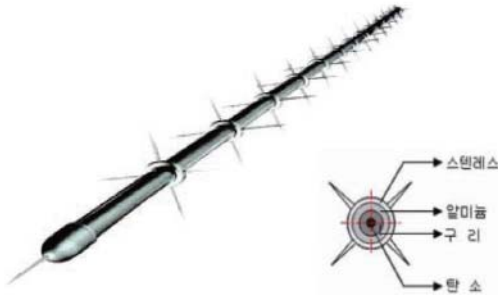

Code Number	규격
JCN100	14 X 1500 L

한전용 접지봉



Code Number	규격
JCN101	D14 X 1000 L (리드단자 22 SQ)

심타식 접지봉

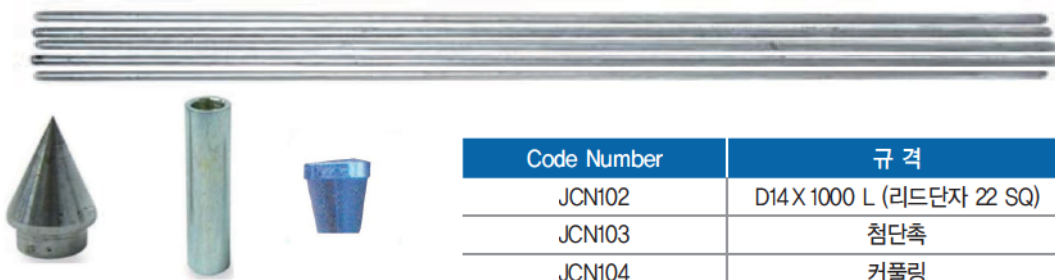

Code Number	규격
JCN102	D14 X 1000 L (리드단자 22 SQ)
JCN103	첨단촉
JCN104	커플링

접지 동판 (GROUND PLATE), 접지 동봉 (GROUND ROD)



Code Number	SIZE (mm)
JCN105	12 X 1000 L
JCN106	14 X 1000 L
JCN107	16 X 1800 L
JCN108	18 X 2400 L
JCN109	19 X 2400 L

Code Number	접지동판 Size
JCN110	300 X 300 X 0.7 T
JCN111	300 X 300 X 1 T
JCN112	300 X 300 X 1.5 T
JCN113	300 X 300 X 2 T
JCN114	500 X 500 X 1.5 T

POWER QUALITY

SURGE PROTECTION

GROUNDING SYSTEM

LIGHTNING PROTECTION

지명원

납품실적

접지자재

접지봉 콘넥타



Code Number	SIZE
JCN115	10~14 mm
JCN116	14~19 mm



Code Number	SIZE
JCN117	10~14 mm
JCN118	14~19 mm

철근 접지 콘넥타



Code Number	Conductor	철근 Size
JCN119	35~150 SQ	13~25 mm

측벽 접지 콘넥타 (U-BOLT TYPE)



Code Number	Conductor	철근 Size
JCN120	35~150 SQ	13~29 mm

버스탭



Code Number	Conductor
JCN121	25~95 SQ

크로스 콘넥타



Code Number	Conductor
JCN122	25~95 SQ

접지자재

GROUND PAD



Code Number	Conductor
JCN123	25~300 SQ

전선 콘넥타 (서비스볼트 콘넥타)



Code Number	Size	넓이	높이	기장
JCN124	38	10	19	36
JCN125	60	11	22	46
JCN126	100	14	30	53
JCN127	150	16	38	68
JCN128	200~250	22	43	71
JCN129	325	27	53	89

수막 처리봉 (주문제작 사양)



Code Number	수막처리봉 (웰딩용)
JCN130	10~300 SQ



Code Number	접지 연결 동봉
JCN131	24 X 510, 24 X 730



Code Number	수막처리봉 (슬리브용)
JCN132	10~300 SQ

방수 슬리브



Code Number	Size
JCN139	10~3000 SQ

C형 슬리브



Code Number	Size
JCN140	10~500 SQ

POWER QUALITY

SURGE PROTECTION

GROUNDING SYSTEM

LIGHTNING PROTECTION

지명원

납품실적

접지자재

뉴트라단자



Code Number	품명
JCN619	5P
JCN620	10P

동단자



Code Number	품명
JCN621	3P
JCN622	5P
JCN623	10P

배관접지본딩



Code Number	Size	Code Number	Size
JCN406	22 C	JCN410	54 C
JCN407	28 C	JCN411	70 C
JCN408	36 C	JCN412	82 C
JCN409	42 C	JCN413	104 C

BARE COPPER WIRE · PVC INSULATED GROUNDING CABLE F-GV



TYPE A

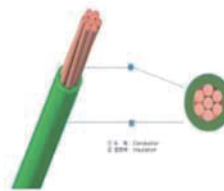

TYPE B

품명
Type A 6 ~ 300 mm ²
Type B 6 ~ 300 mm ²

접지자재

GROUND RECEPTACLE (항공 접지단자)

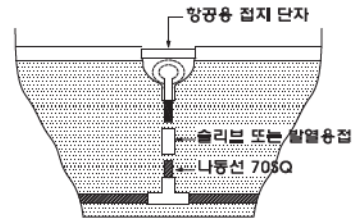
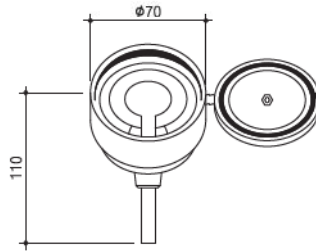

Code Number

JCN400A

GROUND CLAMP (교각 접지단자)

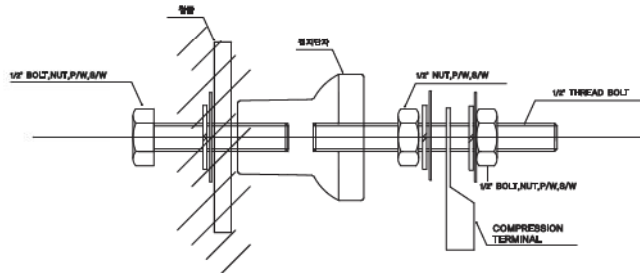

※볼트류는 별도 주문사양

Code Number	Thread	Bolt Size
JCN401A	1/2" Tap	1/2"-20L BRASS BOLT

EARTH BOSS (본딩블럭)

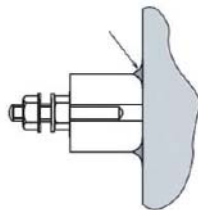

Code Number	Size(mm)	Material
JCN402A	50X50	Steel

POWER QUALITY

SURGE PROTECTION

GROUNDING SYSTEM

LIGHTNING PROTECTION

지명원

납품실적

접지자재

GROUND LUG



Code Number	Type	Material
JCN403A	Type A	Stainless Steel
JCN404A	Type B	H.D.G Steel

STATIC ELECTRICITY CONTROL ROD (정전기 제거봉)

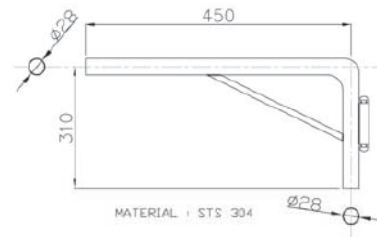

Code Number	Material
JCN405A	Stainless Steel

BONDING JUMPER

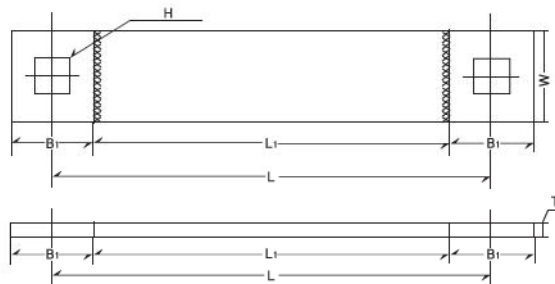
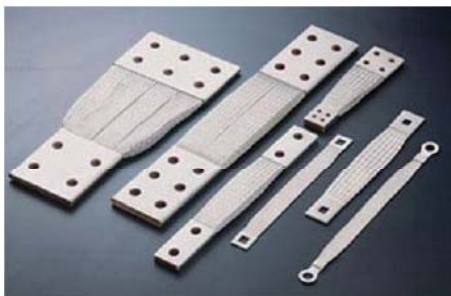

Code Number	규격 (mm)	폭-두께 ± 5%	Design	전압 (A)	길이 (L)	B 1	L1	H
JCN406A	10	15×1	8.1	60	200	20	160	8
	16	20×1.5	14.1	88	250	25	200	11
	25	24×2	21.7	115	250	25	200	11
	35	30×2.5	37.9	162	250	30	190	11
	70	35×3	59.6	217	300	40	220	11

접지자재

INSPECTION PIT (TEST WELL)

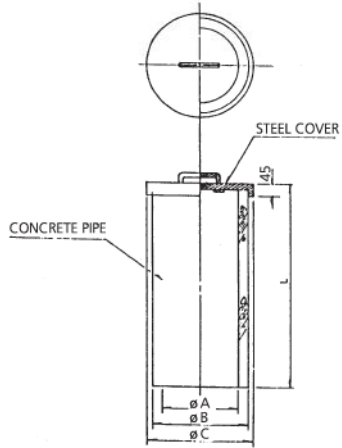

Code Number	Dimension in mm				Remark
	A	B	C	L	
JCN407A	300	400	420	600	with 6holes earth bar

※Material : Body (Concrete), Cover (H.D.G. Steel)

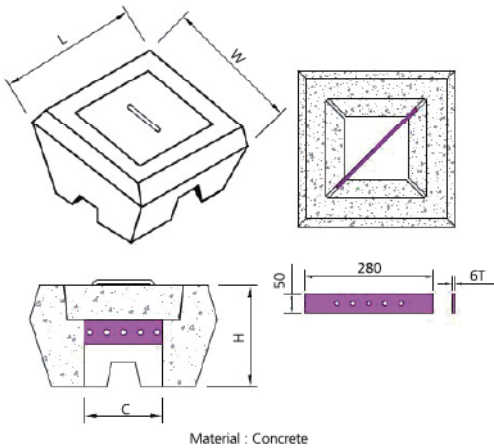

Code Number	Dimension in mm				Remark
	L	W	C	H	
JCN407A	390	390	160	210	with 5holes earthbar

※Material : Body (Concrete), Cover (Concrete)

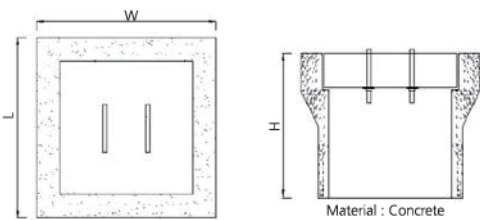

Code Number	Dimension in mm			Remark
	L	W	H	
JCN407A	500	500	400	with 6holes earth bar

※Material : Body (Concrete), Cover (Concrete)

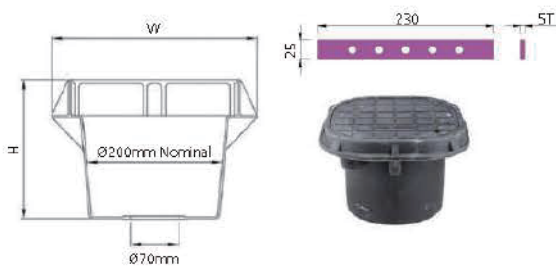

Code Number	Dimension in mm			Remark
	L	W	H	
JCN407A	280	280	180	with 5holes earthbar

※Material : Body - PVC, Cover - PVC

POWER QUALITY

SURGE PROTECTION

GROUNDING SYSTEM

LIGHTNING PROTECTION

지명원

납품실적

접지자재

GROUND TERMINAL BOX (접지 단자함 주문 제작 사양)



Code Number	Division	Box Size	
		50SQ	95SQ
JCN408A	1 CCT	200X300X100	200X300X100
	2 CCT	200X300X100	300X400X100
	3 CCT	300X400X100	300X400X100
	4 CCT	300X400X100	400X400X100
	5 CCT	400X400X100	400X400X100
	6 CCT	400X400X100	500X400X100

PVC GROUND TEST BOX (피뢰접지 단자함)

▶ 피뢰접지 단자함 / 1회로, 2분기



규격 : 200×300×100mm

내부 1회로

내부 2분기

▶ 피뢰접지 단자함 / 3회로



규격 : 300×300×100mm

내부 3회로

■ 피뢰접지 단자함의 특징

- 용벽 및 조적시공이 간편함
- 디자인이 미려하고 견고함
- 터미널은 순동98% 이상 밀링가공 제품
- 다량 생산으로 공사비가 저렴함
- 반영구적인 수명

■ 피뢰접지 단자함의 재질

- BOX : PC/ABS
- COVER : PC/ABS
- 접지단자 및 전비 피스는 스테인레스 제품임.
- 접지단자는 동대를 가공한 일체형임.

Code Number

JCN409A

▶ 공용접지 단자함



Box : 450×300mm / h : 100mm



Cover : 510×360mm / h : 17.5mm

Code Number

JCN410A